

AMANO®

PIX-200

Atomic Time Clock

Operation Manual



Proprietary Notice

This document contains proprietary information and such information may not be reproduced in whole or part without the written permission from Amano Cincinnati, Inc. 140 Harrison Ave., Roseland, New Jersey 07068.

Amano Cincinnati, Inc. reserves the right to make equipment changes and improvements, which may not be reflected in this document. Portions of this document may have been updated to include the latest hardware or firmware version, if applicable.

To ensure safe use of this time recorder/stamp, be sure to thoroughly read this manual in its entirety before any attempt is made to operate the equipment. After you have finished reading this manual, be sure to store it in a safe place for future reference.

Thank You...

For purchasing another fine product from Amano Cincinnati, Inc.

For Safe and proper operation, please carefully read the manual before using the time clock and save it for reference.

Warranty Notice







Any claim for warranty, express or implied, due to the clocks failure to properly receive the radio signal because of interference, whatever may be the source of this interference, are hereby expressly excluded.

The PIX-200 has the atomic clock (radio-controlled clock) feature which displays the current time precisely by automatically receiving time code signals on long wave radio from the transmitting station. The unit receives the time code signal via its built-in antenna system.

Note: This equipment has been tested and found to comply with the limits for a Class A digital device, pursuant to part 15 of the FCC Rules. These limits are designed to provide reasonable protection against harmful interference when the equipment is operated in a commercial environment. This equipment generates uses and can radiate radio frequency energy and, if not installed and used in accordance with the instruction manual, may cause harmful interference to radio communications. Operation of this equipment in a residential area is likely to cause harmful interference in which case the user will be required to correct the interference at his own expense.

GUIDELINES FOR SAFE OPERATION.....	1-3
Chapter 1: Overview	1-5
Specifications	1-5
Names and Functions of Parts	1-6
LCD Display	1-7
Description of Controls (function buttons)	1-7
Print Position Adjustment (Slide Lever).....	1-8
Chapter 2: Getting Started	2-1
Removing the Cover & Packing Material	2-1
Mounting	2-1
Wall Mounting	2-2
Desktop Mounting.....	2-3
Performing a Test Print	2-3
Chapter 3: Program Mode	3-1
Setting the Time (If the Time Displayed is Incorrect)	3-1
Easy Way to Set the Time.....	3-2
Setting the Date (If the Date Displayed is Incorrect)	3-2
Setting the Date Format	3-3
Date Format Table	3-4
Setting the Layout for Customized Comments.....	3-7
Test Printing for Customized Comments	3-8
Changing the Print Position.....	3-9
Setting the Print Pattern	3-9
Setting the Printing Length.....	3-12
Setting the Printing Activation/Detecting Sensor.....	3-13
Setting the Number	3-14
Setting the Initial Number and Auto Reset	3-15
Setting the Repeat Times of a Number.....	3-16
Setting for Daylight Saving Time (DST)	3-17
Displaying Settings: Programming Password and Time	3-18

Chapter 4: Atomic Clock Feature	4-1
Automatic Reception	4-1
Setting the Atomic Clock (Germany, UK and others)	4-3
Setting the Time Zone (US only)	4-4
PIX-200 Atomic Clock/Time Code Signal	4-5
Chapter 5: Maintenance and Troubleshooting	5-1
Ribbon Cartridge Replacement	5-1
Cleaning	5-1
Error Codes	5-2
Chapter 6: Appendix	6-1

	Do not place the unit near kitchen counter or humidifier. Oil, smoke, or steam generating from them may cause fire or shock hazards.
	Do not yank the power cord to disconnect from the outlet. Hold the plug with your hand to do so, or the cord may be damaged, possibly leading to a fire or electric shock.
	Remove the line cord plug from the outlet before transferring the unit, or it may damage the cord, possibly leading to a fire or electric shock.
	Be careful not to contact the print head, as you may get hurt or burned.
	Make sure to insert the power plug as far as it will go. Improper insertion of the plug may develop fire or shock hazards.
	Do not insert or drop any other time card than specified into the slot. Such misuse may cause a fire or electric shock.
	If the unit should be dropped or the case is broken, unplug the unit and contact your dealer for servicing. Further use may lead to a fire or shock hazard.

Relation to the Health and the Environment

The plastic currently used for the outer enclosure of this apparatus does not contain the halogen substance.

Chapter 1: Overview

Before attempting to use the Amano PIX-200 time recorder/stamp, please carefully review Chapter 1: "Overview", and Chapter 2: "Getting Started". This chapter of the manual covers the specifications, accessories, names and functions of parts, LCD Display, description of controls, and print position adjustment.

Specifications

Power Requirements:

- Power Supply: DC 15V
- Power Consumption: 1.2A
- Battery: Optional Lithium Battery for full power reserve in case of power failure.

Ambient Temperature: 14°F to 113°F (-10°C to 45°C)
32°F to 104°F (0°C to 40°C) if using NiMH battery option

Ambient Humidity: 10% to 90% (non-condensing)



Dimensions: 6-1/4"(159 mm) Wide X 6-1/2"(165 mm) High X 6-3/4"(171 mm) Deep.

Weight: Approximately 4.85 lbs. (2.2 kg)

Environment: Indoor use only; dust-free environment. Keep out of direct sunlight.

Accessories

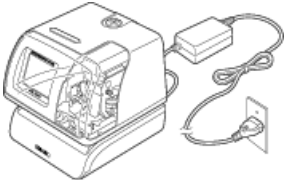
The following accessories are provided with the Amano PIX-200. After unpacking, please ensure that all of the following items are provided:

 <p>PIX-200 (1 unit)</p>	 <p>This operation manual (1 copy)</p>	 <p>Keys (one pair, 2 keys)</p>
---	---	---

- Please note that specifications, appearance, and/or description are subject to change without notice due to product enhancements.
- This manual has been carefully prepared, but Amano assumes no liability for errors and/or omissions. If you should find any errors or unclear information, please contact your Amano dealer.

Names and Functions of Parts

The following describes the names and functions of various parts of the PIX-200.

External View

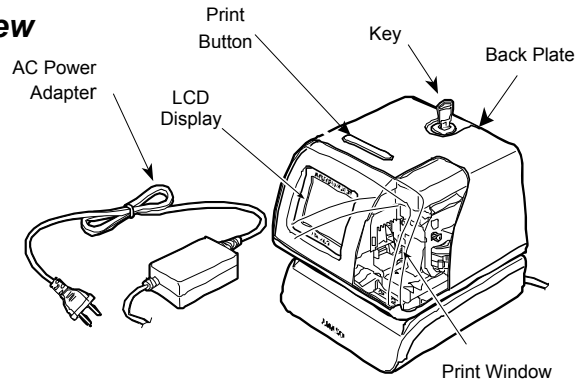

Internal View

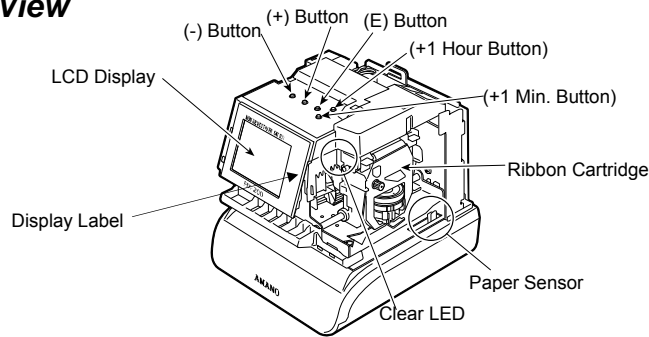

Component Name	Function
AC Adapter	Provides clock power.
Keys	Used to lock and unlock clock cover.
Back Plate	Used to mount the unit to a wall when wall mounting is desired.
LCD Display	Used to display information in the front window, i.e., Time & Date.
Print Button	Press this button to print in "manual" mode, or when setting the printing activation.
Print Window	Large window to assist in accurate printing position.
Buttons	5 control buttons located on top of unit under the cover.
Ribbon Cartridge	Easy-to-replace ribbon cartridge.
Clear LED	Illuminates the printing position to increase visibility.
Paper Sensor	Sensors, which detect the paper position to automatically print.

LCD Display

The LCD display contains an ink capacity gauge. This gauge indicates the amount of ink remaining in the ribbon cartridge using four bar segments, from E (Empty) to F (Full).

The PIX-200 calculates the remaining ink capacity of the ribbon cartridge from the number of imprints made. As the ink capacity decreases, the bars in the gauge will disappear. When the ribbon reaches below 25% capacity, the word "INK" and "E" will blink until the ribbon is replaced and the ink counter is reset. (Refer to page 5-1 for Ribbon Cartridge Replacement and Ink counter reset). The following drawing illustrates the PIX-200 LCD display contents.

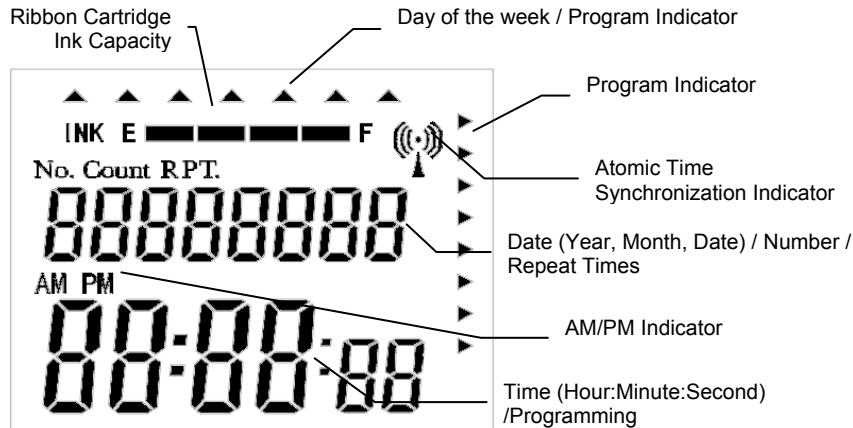

Description of Controls (function buttons)

Normally, the **Display Window** shows the date and time. When you use the Quick Set or Program Mode to change the settings of the PIX-200, the instructions to change the clock are shown in this window.

The 5 function buttons underneath the cover are used to navigate through the Quick Set and Program Mode to change the clock's settings.

- The **(-)** button is used to change the information on the display by decrementing the set value or moving the "▲" to the left.
- The **(+)** button is used to change the information on the display by incrementing the set value or moving the "▲" to the right.
- The **E** button is used to accept the information shown on the display and save it in memory.
- The **+1 HOUR** button advances the hour in the display by increments of 1.
- The **+1MIN.** button advances the minutes in the display by increments of 1.

Print Position Adjustment (Slide Lever)

The print position from the paper edge is adjustable by pressing and sliding the print position adjuster (slide lever) located on the right outside bottom of the PIX-200 unit as illustrated in the diagram.

The slide lever can be adjusted using the latching mechanism which can move a total of 17 increments with each increment = 1.5mm (for a total movement = 25.5mm). This adjuster will move the paper-detecting sensor forward or backward to change the margin from the paper edge to the print as illustrated in the following diagram.

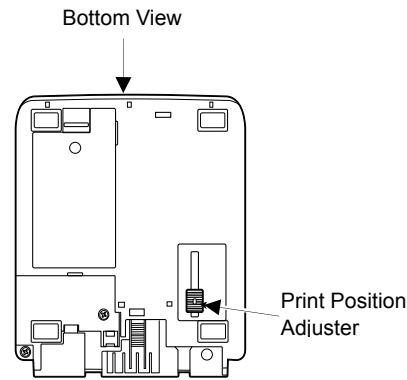

The minimum distance from the form edge to print is approximately 0.5mm - 2.0mm. This is achieved when you slide the slide lever to the front of the machine. The maximum distance from form edge to print is approximately +25.5mm. This is achieved when you slide the slide lever to the back of the machine.

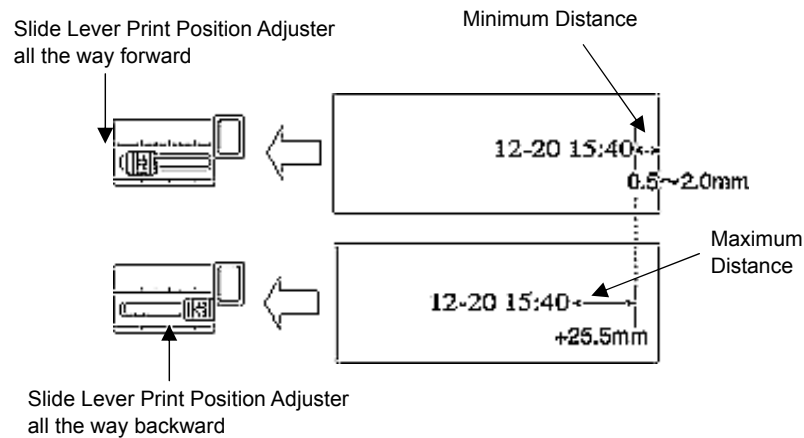

Chapter 2: Getting Started

Before using the Amano PIX-200 time recorder/stamp, please carefully review this chapter of the manual, which covers removing cover and packing material, mounting, and performing a test print.

Removing the Cover & Packing Material

You must remove the packaging spacers from the printer block and the Printer Carriage before attempting to use your PIX-200.

Step 1. Insert the key provided and turn the key counter clockwise to unlock the cover.

Step 2. Lift the cover to remove.

Step 3. Remove the spacers between the Ribbon Cartridge and the Printer Carriage.

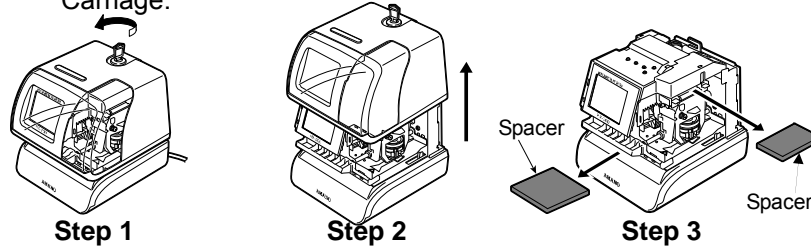

Mounting

When choosing a mounting location for your PIX-200, you should consider the following:

- The mounting surface or hardware must be capable of supporting the unit's weight, 2.2 kg (4.85 lbs).
- The area must be within the specified operating temperature range: 14°F~113°F (-10°C~45°C), 10% ~90% relative humidity.
- The unit should be in close proximity to a power source or wall outlet.
- The following conditions should not exist:

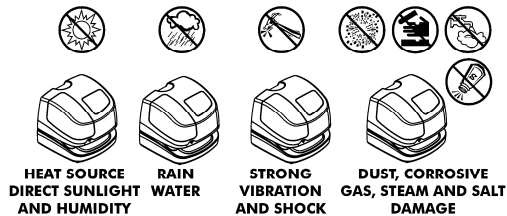

- The unit should be mounted in a place able to receive radio signals for atomic clock signal reception (see page 4-2, for more details).

Wall Mounting

To wall mount perform the following:

1. Remove the cover, and remove the back plate by pressing on the tab located on the bottom of the unit towards the rear, and rotating the bottom of the plate away from the clock.
2. Using the back plate as a template, mark the lower mounting hole on the wall.
3. Mount the plate using a #10 wood screw (or equivalent).
4. Level the back plate and mark the location of the two upper mounting holes. Secure to the wall using #10 wood screws (or equivalent).
5. Feed the cable of the AC power adapter through one of the holes in the back plate.
6. Align the clock with the two upper tabs on the back plate. Tilt the back of the clock upwards to fully insert the back plate tabs into the clock. Be careful not to pinch the power cord with the bracket.
7. Once the tabs are inserted, tilt the clock back down and push it against the wall. The tabs will snap into place.
8. Replace the cover and lock it in place with keys provided.

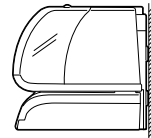
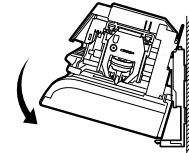
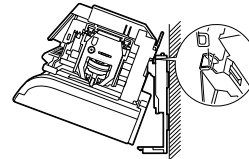
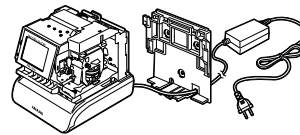
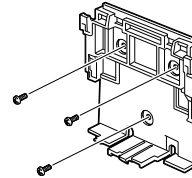
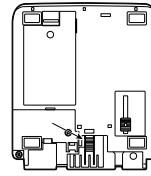

Note: Wall mounting should only be performed by authorized Amano dealers. If the PIX-200 is improperly mounted, it could fall, resulting in damage to the unit or personal injury. When mounting the PIX-200 on a concrete wall, or other special wall material, special screws may be required.

Note: The display LED will not light up until the cover has been put back on.

Desktop Mounting

The PIX-200 should be placed on a level surface with adequate ventilation.

Performing a Test Print

To test print perform the following:

1. Make sure the AC adapter for the PIX-200 is plugged in.
2. The LED should light up and illuminate the printing position.
3. Insert a piece of paper or time card along the guide into the PIX-200. The clock will automatically print YEAR, MONTH, DATE and TIME with AM or PM.

IMPRINT SAMPLE:

'05 JUN 1 3:05PM

4. If the imprint format is satisfactory, the PIX-200 is ready for use.

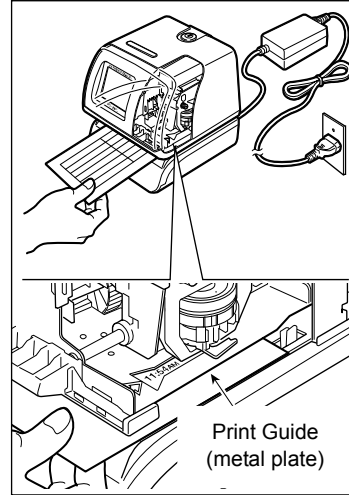

* This page intentionally left blank *

Chapter 3: Program Mode

Make sure the AC power adapter is plugged in and connected to the PIX-200 before making changes to the clock settings. Unlock and remove the cover. Locate the **(-)**, **(+)**, **E,+1 HOUR**, and **+1 MIN.** buttons on top of the clock.

Note: Replacing the cover during any step of programming will return the clock to normal date and time display.

Setting the Time (If the Time Displayed is Incorrect)

The illustrations on the right show samples of the displays. The shaded area means that the symbols, numbers or characters are blinking.

To set the correct time perform the following:

1. Unlock and remove the cover.
2. Press the **(+)** and **(E)** buttons on the top of the unit at the same time, holding down for 2 seconds until **Set UP Pro9** appears on the display. The **▲** on the top of the display will be blinking.
3. Press the **(-)** or **(+)** buttons to position the **▲** under **MON**.
4. Press the **(E)** button once to display the time and the Hour display will be blinking. While the Hour display is blinking, adjust time to the desired hours using the **(-)** or **(+)** buttons. Once you have the correct hour, press the **(E)** button to confirm and move to the minute.
5. While the Minute display is blinking, adjust the minutes using the **(-)** or **(+)** buttons to obtain the desired minutes. Once you have the correct minute, press the **(E)** button to confirm and move to the seconds. The seconds will start from **"00"** at the time you press the **(E)** button. However, if you did not change the minute, the seconds will not change.
6. The display will return to the clock display. If you need to return to the "set up program" **[Set UP Pro9]**, press the **(E)** button again. Replace the cover and the display will automatically return to normal date and time display.

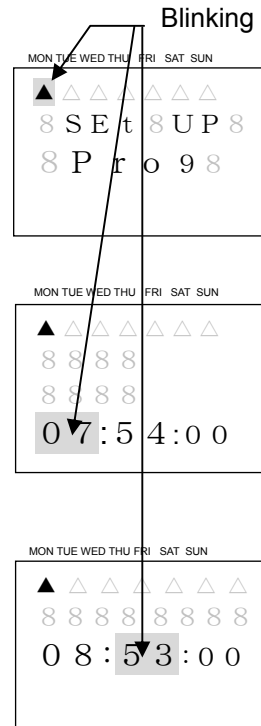

Note: When the Atomic Clock is built-in and the clock is being used in Europe, please check if the Atomic Clock setting is correct. (Refer to *page 4-3*).

Note: When you are using the PIX-200 in the US, please check if the time zone setting is correct. (Refer to *page 4-4*).

Easy Way to Set the Time

1. Unlock and remove the cover.
2. Press the **(+1 HOUR)** to change the hour, and **(+1 MIN.)** to change the minute on the top of the unit until the desired time (hours and minutes) appear on the display. The seconds will not start from "00", but will continue to advance while the clock is being set.

Note: these buttons only advance the hour and/or minute one increment per depression. The date will not change.

3. Replace and lock the cover once you have set the correct time.

Setting the Date (If the Date Displayed is Incorrect)

The illustrations to the right show samples of the displays. The shaded area means that the symbols, numbers or characters are blinking.

To set the correct date perform the following:

1. Unlock and remove the cover.
2. Press the **(+)** and **(E)** buttons on the top of the unit at the same time, holding down for 2 seconds until **SEt UP Pro9** appears on the display. The "▲" on the top of the display will be blinking.
3. Press **(+)** button once to position the "▲" under **TUE**.
4. Press the **(E)** button once to display the date and the Month will be blinking. While the Month display is blinking, adjust month to the desired month using the **(-)** or **(+)** buttons. Once at the correct month, press the **(E)** button to confirm and move to the day.
5. While the day is blinking, adjust the day using the **(-)** or **(+)** buttons to obtain the desired day. Once you have the correct day, press the **(E)** button to confirm and move to the Year.

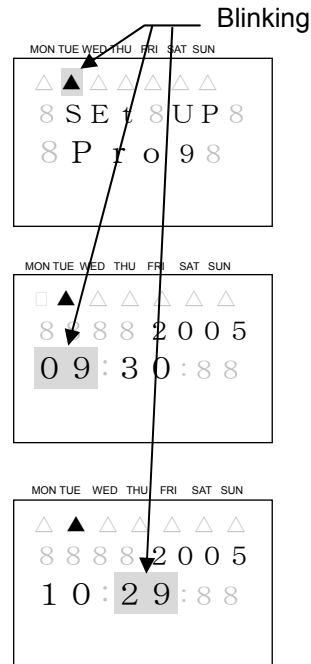

6. While the Year display is blinking, adjust the year using the (-) or (+) buttons to obtain the desired year. Once you have the correct year, press the (E) button to confirm and return back to the “set up program” display.
7. If you are finished programming the unit, replace the cover to return the clock to normal operation mode.

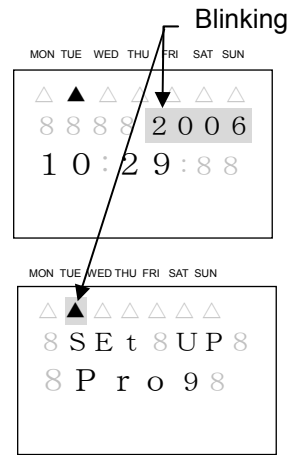

Setting the Date Format

The illustrations on the right show samples of the displays. The shaded area means that the symbols, numbers or characters are blinking.

To set the desired date format perform the following:

1. Unlock and remove the cover.
2. Press the (+) and (E) buttons on the top of the unit at the same time, holding down for 2 seconds until **SEt UP Pro9** appears on the display. The “▲” on the top of the display will be blinking.
3. Press the (+) button twice to position the “▲” under **WED**.
4. Press the (E) button once to display **Pr ordEr** (the print order (style) format) and the code number will be blinking. While the code number is blinking, adjust code number to the desired number (see the following Date Format Table) by using the (-) or (+) button. Once you have selected the code number, press the (E) button to confirm and return back to the “set up program” display.

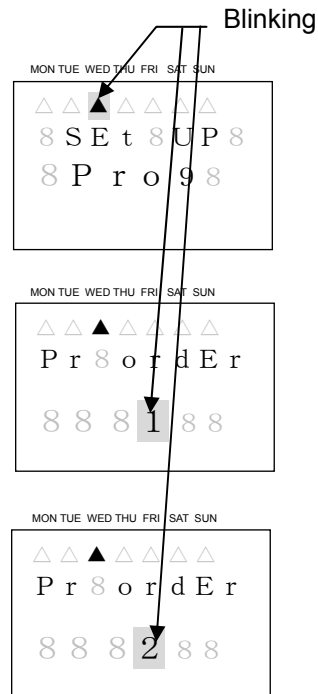

- Replace the cover and the display will automatically return to normal operating mode.

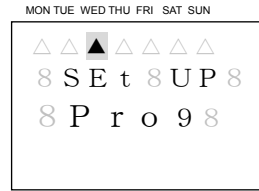

Date Format Table

Y=Year, M=Month, D=Date, W=Day of the week, h=Hour, m=Minute, s=Second, C=Comment, N=Number (6 digits except No.21 (2 digits) and No. 22 (4 digits)). (Factory Default) = No. 3

Code	Imprint Format	Print Example	Code	Imprint Format	Print Example
1	Y/M/D hms	'05/JUN/ 1 3:05PM 05s	17	C D hm	RCVD 1 3:05PM
2	YMD hms	'05 JUN 1 3:05PM05s	18	YMD C	'05 JUN 1 RCVD
3	YMD hm	'05JUN 1 3:05PM	19	MDY C	JUN 1'05 RCVD
4	MDY hm	JUN 1'05 3:05PM	20	DMY C	1 JUN' 05 RCVD
5	DMY hm	1 JUN'05 3:05PM	21	N YMD hms	1'
6	YMD	'05 JUN 1	22	N YMD hm	1''05JUN 1 3:05PM
7	MD hm	JUN 1 3:05PM	23	N YMD	1 '05 JUN 1
8	DM hm	1 JUN 3:05PM	24	N MDY	1 JUN 1' 05
9	MD	JUN 1	25	N DMY	1 1 JUN' 05
10	W D hm	WE 1 3:05PM	26	N MD hm	1 JUN 1 3:05PM
11	W hm	WE 3:05PM	27	N D hm	1 1 3:05PM
12	D hm	1 3:05PM	28	YMD N	'05JUN 1 1
13	hm	3:05PM	29	MDY N	JUN 1' 05 1
14	C YMD	RCVD'05 JUN 1	30	DMY N	1 JUN' 05 1
15	C MDY	RCVD JUN 1'05	31	N	1
16	C DMY	RCVD 1 JUN'05	32	Customized comments imprint (up to 3 lines)	

Setting Customized Comments (A special print style)

The illustrations to the right show samples of the displays.

The shaded area means that the symbols, numbers or characters are blinking.

To set the desired customized comment print style (order) perform the following:

1. Unlock and remove the cover.
2. Press the **(+)** and **(E)** buttons on the top of the unit at the same time, holding down for 2 seconds until **Set UP Pro9** appears on the display. The **▲** on the top of the display will be blinking.
3. Press the **(+)** button twice to position the **▲** under the **WED**.
4. Press the **(E)** button once to display the print order (style) format and the code number will be blinking. While the code number is blinking, adjust code number to **32** (print style) by using the **(-)** or **(+)** button.
5. Press the **(E)** button once to confirm the **32** and show the **P1 inPut CodE** in the display. Press the **(E)** button once to program the 1st line. The **“Prn LinE 1”** display means that you can program the 1st line. The **“0”** on the left side of the Line number shows the printing length of the comment in mm [max. length is 35mm].
6. Press **(E)** button while **“1”** is blinking.
7. You will see the **“LinE1 1”** display with **“En”** blinking. **“LinE1 1”** means the 1st character on Line 1, and **“En”** means the end of the sentence.
8. Press the **(-)** or **(+)** button and select the character code referring to the diagram of character code (page 6-2). Press the **(E)** button every time you confirm one character.
9. Once you finish selecting the characters for line 1, press the **(E)** button. This will return the display back to **“P1 inPut CodE”**.

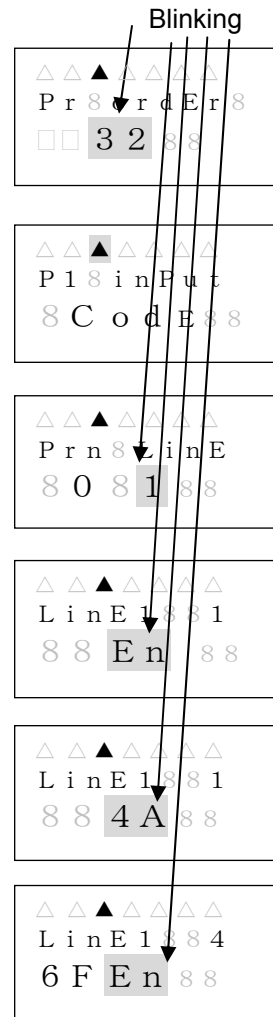

10. To enter the comments on Line 2, Press (E) and press (+) when the line number is blinking. You can program line 3 by repeating the previous steps.

11. Once you finish programming Customized Comments, press the (E) button to go back to the "P1 inPut Code" Display.

12. If you want to check the printing length, press the (E) button and select the line by pressing the (-) or (+) button. You will see the length in mm to the left of the blinking line number. (The sample display on the right shows that line 1 is 35mm)

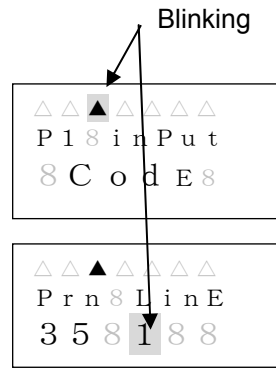

Note: When the value exceeds the maximum length (35mm), the "Error 05" will appear on the display when you put the cover on. Please refer to page 5-2, "Error Codes".

Note: You can choose the character font when programming the customized comments. In order to make the imprint clearer, we recommend you to use Two-Byte Font. Please refer to page 6-3, "Diagram of Font".

Use the following codes to edit the customized comments:

Code	Function
in	Insert character
dL	Delete character
En	End of the sentence

Use the following codes to change the font for customized comments:

Code	Function
J	Start Two-Byte
Jn	Undo Two-Byte
L	Start Emphatic Byte
LL	Start Double-Width Byte
Ln	Undo Emphatic/Double-Width Byte
Un	Undo Space Character

Sample of changing the font of "D" "E" "F" from One-Byte to Two-Byte

ABCDEFGHI → 41, 42, 43, 44, 45, 46, 47, 48, 49

ABCDEFGHI → 41, 42, 43, in, J, 44, 45, 46, in, Jn, 47, 48, 49

See Chapter 6 – Appendix, and the paragraph "Diagram of Character Code" for more information on codes.

How to delete the customized comment

When the print line number is blinking, (i.e., **Prn LinE 1**) press (**+1 HOUR**) button for 3 seconds. The blinking will stop and the line number will light steadily. Once the printing length returns to **0** and the line number starts blinking again, the line you have selected and all the subsequent lines will be deleted.

Setting the Layout for Customized Comments

The illustrations to the right show samples of the displays. The shaded area means that the symbols, numbers or characters are blinking.

To set a layout for customized comments perform the following:

1. Unlock and remove the cover.
2. Press the (**+**) and (**E**) buttons on the top of the unit at the same time, holding down for 2 seconds until **SEt UP Pro9** appears on the display. The “▲” on the top of the display will be blinking.
3. Press the (**+**) button twice to position the “▲” under the **WED**.
4. Press the (**E**) button once to display the print order (style) format and the code number will be blinking. While the code number is blinking, adjust code number to **32** (print style) by using the (-) or (+) buttons.
5. Press the (**E**) button once to confirm the **32** and display **P1 inPut CodE**.
6. At the **P1 inPut CodE**, press the (**+**) button once and the display will change to “**P2 Print LAyout**”. Press the (**E**) button once to select the “**LAyout**”.
7. Press the (-) or (+) button to select the desired layout. The layout selections are; right (**ri9ht**), center (**CentEr**), and left (**LEFt**). Press the (**E**) button to confirm the selection and display “**P3 tE5t Print**”.

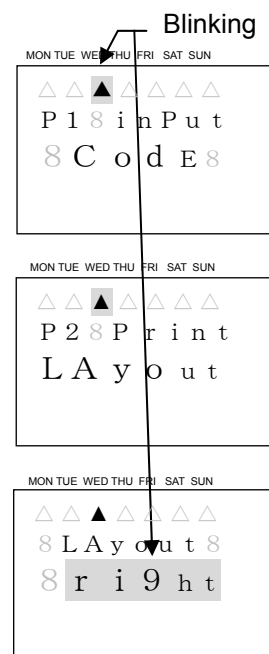



Test Printing for Customized Comments

The illustrations to the right show samples of the displays.
The shaded area means that the symbols, numbers or characters are blinking.

To test print perform the following:

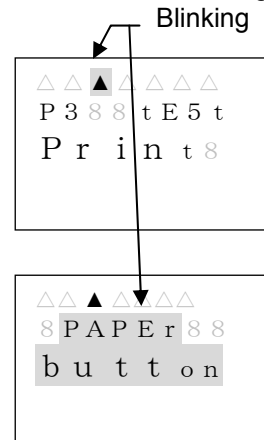
1. After confirming the layout, press the **(E)** button to test print the customized comments.
2. When the **"PAPeR button"** display is blinking, insert a paper and press the **(-)** or **(+)** button to perform a test print.
3. Press the **(E)** button to end a test print.
4. Press the **(E)** button once at the **"P4 End"** display to return to **"Set UP Pro9"** on the display.



 **WARNING:** Touching the printing area while test printing may cause an accident resulting in injury.

Changing the Print Position

The illustrations to the right show samples of the displays. The shaded area means that the symbols, numbers or characters are blinking.

You can set the print position in two directions (the left or right side of the paper). The factory default is set to imprint on the right side of the paper.

To change print direction perform the following:

1. Unlock and remove the cover.
2. Press the **(+)** and **(E)** buttons on the top of the unit at the same time, holding down for 2 seconds until **SEt UP Pro9** appears on the display. The “▲” on the top of the display will be blinking.
3. Press the **(+)** button three times to position the “▲” under the **THU**.
4. Press **(E)** button once to display “Prn Po5n ri9ht” blinking.
5. Press the **(-)** or **(+)** button to change the display to “LEFt” blinking.
6. Press the **(E)** button once to confirm the setting, and return back to the “SEt UP Pro9” display.

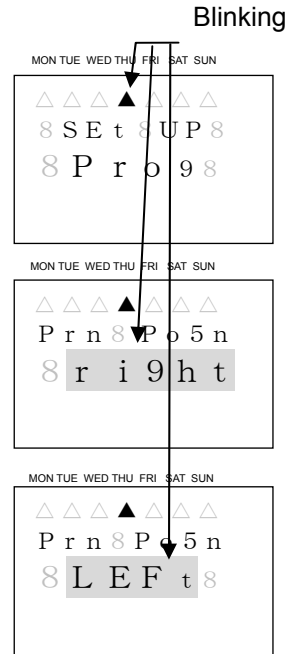

Setting the Print Pattern

The following illustrations show samples of the displays. The shaded area means that the symbols, numbers or characters are blinking.

In this setup, the Year digit, the print of Hyphen (-) between month and date, the printing type of Hour, the printing type of Minutes (Refer to *page 6-4* “Diagram of Printing Type of Minutes”), the Language, the preprogrammed comment, the type of Zero and the print of Leading Zero can be set.

To set the print pattern perform the following:

1. Unlock and remove the cover.
2. Press the **(+)** and **(E)** buttons on the top of the unit at the same time, holding down for 2 seconds until **Set UP Pro9** appears on the display. The **▲** on the top of the display will be blinking.
3. Press the **(+)** button four times to position the **▲** under the **FRI**.
4. Press **(E)** button once to display **P1 Print YEAr** to set the year digit.
5. Press **(E)** button again to display **YEAr Prn 2** to set the year digit. While the **2** is blinking, press the **(-)** or **(+)** button to select either **“2”** digit or **“4”** digit.
6. Press the **(E)** button once to confirm the setting, and display **P2 Print HYPhen** to set the hyphen between the month and date. Press the **(E)** button again to display **HYPhn Pr offF**. While **offF** is blinking, select either **“off”** or **“on”** by pressing the **(-)** or **(+)** button.
7. Press the **(E)** button once to confirm the setting, and display **P3 Print Hour** to set the printing style of hour. Press the **(E)** button again to display **Hour AM PM Prn 12H**. While the **12H** is blinking, select either **“AM PM 12H”** or **“24H”** by pressing the **(-)** or **(+)** button.
8. Press the **(E)** button once to confirm the setting, and display **P4 Print minUt** to set the printing style of minutes. Press the **(E)** button again to display **min Prn 60**. While the **60** is blinking, select either **“60”**, **“100A”**, **100b(5/100)**, or **“10”** by pressing the **(-)** or **(+)** button. [60 = 60 seconds/per, 100A = 100's of a minute, 100b = 5/100's of a minute, and 10 = 1/10th of a minute].
9. Press the **(E)** button once to confirm the setting, and display **P5 Print Lan9u** to set the printing language. Press the **(E)** button again to display **LAn9u Pr**

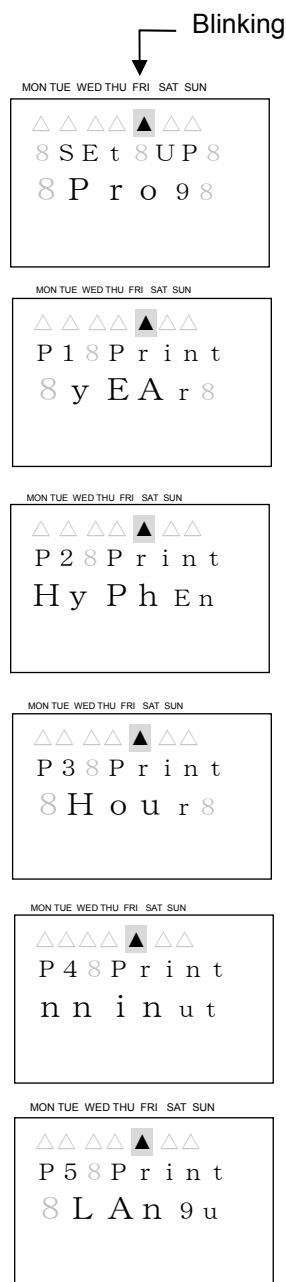

En9Lih". While the **En9Lih** is blinking, select either "English", "Spanish", "French", "German", "Italian", "Portugese", "Roman", "123456", or "Japan" by pressing the (-) or (+) button.

- Press the (E) button once to confirm the setting, and display "**P6 Print ConnEnt**" to set the preprogrammed comment. Press the (E) button again to display "**ConnEnt 1**". While the 1 is blinking, select from number "0" to "12" by pressing the (-) or (+) button. Refer to the following table for a list of preprogrammed comments:

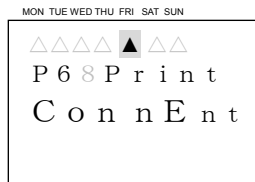

No.	Option	Sample (Eng)	No.	Option	Sample (Eng)
0	Received	RCVD	7	Completed	CMPL'D
1	Sent	SENT	8	Origin	ORIGN
2	Faxed	FAXED	9	File	FILE
3	Void	VOID	10	In	IN
4	Paid	PAID	11	Out	OUT
5	Confirmed	CFM'D	12	Used	USED
6	Approved	APR'D			

- Press the (E) button once to confirm the setting, and display "**P7 SLASH 2Ero**" to set the printing style of Zero. Press the (E) button again to display "**SLASH 0**". While the **oFF** is blinking, select either "**oFF**" or "**on**" by pressing the (-) or (+) button. (Slash Zero on = Ø)

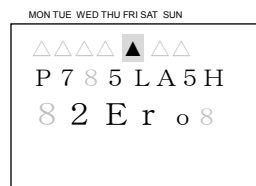

- Press the (E) button once to confirm the setting, and display "**P8 LEAd 2Ero**" to set the printing of Leading Zeros. Press the (E) button again to display "**Print 0**". While the "**r oFF**" is blinking, select either "**r oFF**", "**C oFF**", "**L oFF**", or "**on**" by pressing the (-) or (+) button. Please refer to the following table for the meaning of the Leading Zero codes:

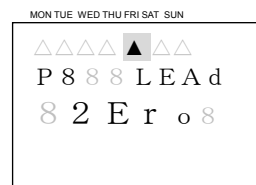

Code	Meaning
On	Print the leading 0
R oFF	Disable 0 and print the number right aligned
C oFF	Disable 0 and print the number centered
L oFF	Disable 0 and print the number left aligned

- Press the **(E)** button once to confirm the setting, and display **“P9 End”** to finish setting the printing pattern. Press the **(E)** button once again to return back to the **“SEt UP Pro9”** display.

Setting the Printing Length

The illustrations to the right show samples of the displays. The shaded area means that the symbols, numbers or characters are blinking.

The PIX-200 will automatically change the character font to accommodate the allowed print length when you set the print length. However, if you have selected to use the Customized Comments, this function is not performed and the font is not automatically changed to vary the printing length. The printing length is input in millimeters (MM). If the value is smaller than the minimum length, you will see an error message (**Error 05**) when the cover is put back on. The minimum length depends on the imprint format you have chosen, while the maximum length is 35mm.

To change print length perform the following:

- Unlock and remove the cover.
- Press the **(+)** and **(E)** buttons on the top of the unit at the same time, and hold down for 2 seconds until **SEt UP Pro9** appears on the display. The **“▲”** on the top of the display will be blinking.
- Press the **(+)** button five times to position the **“▲”** under the **SAT**.
- Press the **(E)** button once to display **“Pr LEnt h”** blinking to select the printing length
- Press the **(-)** or **(+)** button to select the desired print length. Press the **(E)** button to confirm the setting and return the display to **SEt UP Pro9**. If an **Error 05** message should appear on the screen, change the print length by repeating steps 4 and 5.

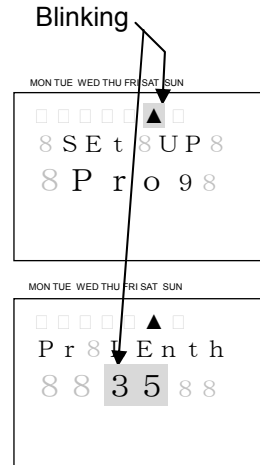

Setting the Printing Activation/Detecting Sensor

PIX-200 has two paper detecting sensors, which allow it to automatically print when a card or piece of paper is inserted. In this setup, you can select the printing activation (manual button, sensor or both) and detecting sensor method (Use the center sensor, Use the Edge sensor or Use both) as detailed in the following table.

Mode	Code	Function
Automatic	Auto	Will automatically print by inserting a piece of paper/time card
Manual	button	Print by pressing the Print Button
Either	Au Btn	Print by pressing the Print Button or inserting a paper/time card

To set the print sensor perform the following:

1. Unlock and remove the cover.
2. Press the **(+)** and **(E)** buttons on the top of the unit at the same time, holding down for 2 seconds until **SEt UP Pro9** appears on the display. The “▲” on the top of the display will be blinking.
3. Press the **(+)** button six times to position the “▲” under the **SUN**.
4. Press **(E)** button once to display “**P1 Print tri9Er**” to set the printing activation.
5. Press **(E)** button again to display “**tri 99Er Au btn**”. While the **Au btn** is blinking, press the **(-)** or **(+)** button to select either “**Au btn**”, “**Auto**”, or “**button**”.
6. Press the **(E)** button once to confirm the setting, and display “**P2 PAPER dEtEct**” to set the paper detect sensor. Press the **(E)** button again to display “**dEtEct CEntEr**”. While **CEntEr** is blinking, select either “**CEntEr**” (use only the center sensor), “**Ed9E**” (use only right edge sensor), or “**CE Ed9**” (use both sensors) by pressing the **(-)** or **(+)** button.
7. Press the **(E)** button once to confirm the setting, and display “**P3 End**” to finish setting the printing pattern. Press the **(E)** button once again to return back to the “**SEt UP Pro9**” display.

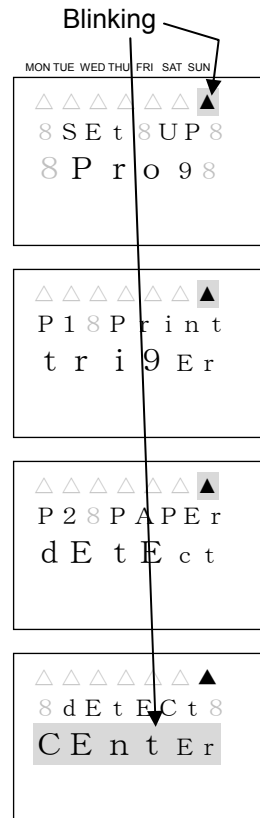

Setting the Number

The illustrations to the right show samples of the displays. The shaded area means that the symbols, numbers or characters are blinking.

In this setup, you can select the starting number for sequential number printing and the number of digits for the printed number. Please make sure that you have selected the imprint format, which includes number (Refer to *page 3-4*, "Print Style Format") or you have included "number" (Code No.19) when you have programmed the customized comment. Please refer to *page 6-1*, "Diagram of Character Code" for character code information.

To set the printed number perform the following:

1. Unlock and remove the cover.
2. Press the **(+)** and **(E)** buttons on the top of the unit at the same time, holding down for 2 seconds until **SEt UP Pro9** appears on the display. The "▲" on the top of the display will be blinking.
3. Press the **(+)** button seven times to position the "▲" alongside the 1st line in the upper righthand corner of the display, alongside "NUMBER" (on the label).
4. Press **(E)** button once to display "P1 Print nubEr" to set the starting number (1st digit thru 8th digit depending upon how many digits are selected in the following step 5). Press the **(E)** button once again, and the number to be changed will be blinking. Select the number (blinking digit) by pressing **(-)** or **(+)** button (the choices for each digit are 0 – 9).

To move to the 2nd digit, press the **(E)** button once again and the next number to be changed will be blinking. Continue pressing the **(E)** to advance one digit to the right each time. Keep advancing to the right and define all digits shown on the display by following the above procedure. After the last digit displayed has been defined, press the **(E)** button to confirm your setting and display **P2 nubEr di9it**.

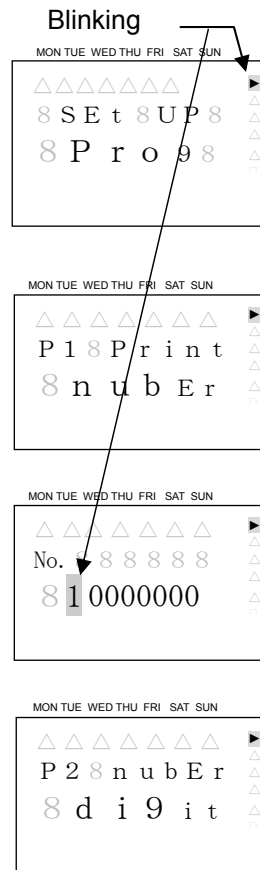

- From the “**P2 nubEr di9it**” display set the number of digits for the number printed by pressing (**E**) button once to display **No. di9it** with a blinking number. Select the number of digits for the printed number by pressing (-) or (+) button. (The number of available digits are 1 to 8). Press the (**E**) button once to confirm the setting and display **P3 End**. Press the (**E**) button once again to return the display to **SEt UP Pro9**.

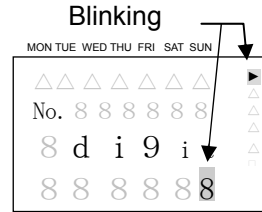

Setting the Initial Number and Auto Reset

The illustrations to the right show samples of the displays. The shaded area means that the symbols, numbers or characters are blinking.

In this setup, the sequentially printed number will automatically be reset to the initial number that has been programmed.

To set the initial number perform the following:

- Unlock and remove the cover.
- Press the (+) and (E) buttons on the top of the unit at the same time, holding down for 2 seconds until **SEt UP Pro9** appears on the display. The “▲” on the top of the display will be blinking.
- Press the (+) button eight times to position the “▲” alongside the 2nd line from the upper righthand corner of the display, alongside “NUMBER AT-RESET” (on the label).
- Press (E) button once to display “**P1 nubEr initAL**” to set the initial number by pressing (E) button once and the number to be changed will be blinking. Select the desired number by pressing (-) or (+) button. To move to the next digit, press the (E) button once again and the next number to be changed will be blinking. Continue pressing the (E) to advance to the right thru all the digits. Press the (E) button to confirm your setting and display **P2 Auto rE5Et**.

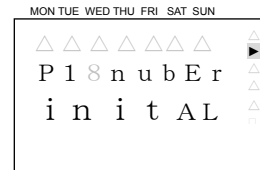

- From the “**P2 Auto rE5Et**” display set the auto reset by pressing (**E**) button once to display **Au rE5Et** with a blinking **on** or **oFF**. Select on or off by pressing (-) or (+) button. Press the (**E**) button once to confirm the setting.
- If “on” is selected the display will show **00:00** clock reading with blinking hours. Press (-) or (+) button to set the hours, and press the (**E**) button to move to blinking minutes. Press (-) or (+) button to set the minutes.
- Press the (**E**) button once to confirm the setting and display **P3 End**. Press the (**E**) button again to return the display to **SEt UP Pro9**.



Setting the Repeat Times of a Number

The illustrations to the right show samples of the displays. The shaded area means that the symbols, numbers or characters are blinking.

In this setup, the repeat times for a number can be set. This function is useful when the same number needs to be imprinted on more than one paper. (Repeat times can be set from 1 to 9)

To set the repeat times for a number perform the following:

- Unlock and remove the cover.
- Press the (+) and (**E**) buttons on the top of the unit at the same time, holding down for 2 seconds until **SEt UP Pro9** appears on the display. The “▲” on the top of the display will be blinking.
- Press the (+) button nine times to position the “▲” alongside the 3rd line down from the upper righthand corner of the display alongside “NUMBER REPEAT” (on the label).
- Press (**E**) button once to display “**No. rEPEAt**” to set the repeat times number which will be blinking. Select the desired number by pressing (-) or (+) button. Press the (**E**) button to confirm your setting and display **SEt UP Pro9**.

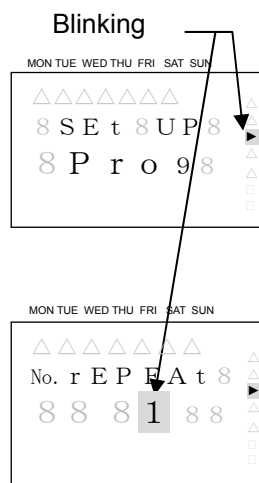

Setting for Daylight Saving Time (DST)

The Daylight Saving Time Function operates in the following manner:

- For use in the US, when 2:00am comes on the first day of daylight saving time, the clock automatically gains one hour to show 3:00am. (The clock will change from 1:59am to 3:00am for beginning of DST)
- For use in the US, when 2:00am comes on the last day of daylight saving time, the clock will automatically lose one hour and return to 1:00am. (The clock will change from 1:59am to 1:00am for the end of DST)
- For use in Germany, when 3:00am comes on the last day of daylight saving time, it automatically loses one hour and returns to 2:00am. (The clock will change at 2:59am to 2:00am for the end of DST)

The factory default of DST is as follows. You can set DST on by setting the begin time and ending time even though the factory default is DST Off.

	With Atomic Clock	Without Atomic Clock
United States	DST On	-
Germany & UK	DST On	DST On
Japan & Others	DST Off	DST Off

The illustrations to the right show samples of the displays. The shaded area means that the symbols, numbers or characters are blinking.

To set Daylight Saving Time perform the following:

1. Unlock and remove the cover.
2. Press the **(+)** and **(E)** buttons on the top of the unit at the same time, holding down for 2 seconds until **SEt UP Pro9** appears on the display. The “▲” on the top of the display will be blinking.
3. Press the **(+)** button ten times to position the “▲” alongside the 4th line down from the upper righthand corner of the display alongside “D.S.T.” (on the label).
4. Press **(E)** button once to display “**bEgn2006040288**” to set the beginning date of Daylight Saving Time and the month number will be blinking. Select the desired month by pressing **(-)** or **(+)** button. Press the **(E)** button to confirm your month setting and now the date will be blinking. Select the desired date by pressing **(-)** or **(+)** button.

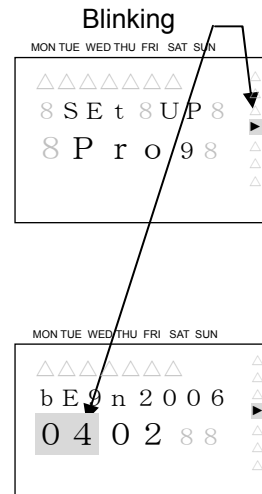

Press the **(E)** button to confirm the year setting and now the display (i.e., **End 2006 1029**) will be for the ending date of Daylight Saving Time and the month will be blinking. Select the desired ending month by pressing **(-)** or **(+)** button. Press the **(E)** button to confirm the ending month setting and now the ending date will be blinking. Select the desired ending date by pressing **(-)** or **(+)** button. Press the **(E)** button to confirm the ending date setting and now the ending year will be blinking. Select the desired ending year by pressing **(-)** or **(+)** button.

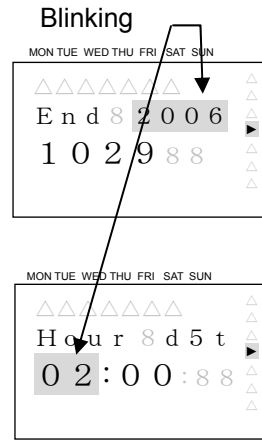

5. Press the **(E)** button to confirm the ending year setting and now the display will show **"Hour dSt 02:00"** and the hours will be blinking. This allows the D.S.T. execution time on the beginning of the day to be set. Select the desired beginning hour (in military time format) by pressing **(-)** or **(+)** button. Press the **(E)** button to confirm your setting and display **SEt UP Pro9**.

Displaying Settings: Programming Password and Time

The illustrations to the right show samples of the displays. The shaded area means that the symbols, numbers or characters are blinking.

To set Display and Password perform the following:

1. Unlock and remove the cover.
2. Press the **(+)** and **(E)** buttons on the top of the unit at the same time, holding down for 2 seconds until **SEt UP Pro9** appears on the display. The **"▲"** on the top of the display will be blinking.
3. Press the **(+)** button eleven times to position the **"▲"** alongside the 5th line down from the upper righthand corner of the display alongside **"OTHERS"** (on the label).



- Press (**E**) button once to display “**P1 LCd diSPly**” to set the display. Press (**E**) button once to select either **12-31-06** which displays the Month-Date-year, or **No. 12345678** which displays the number, or **No. RPT. 123456 9** which displays the number and repeat times, or **Line 3** which displays the line number of the customized comment, or “**L-6 rAdo**” which displays the level of radio wave strength for the Atomic Clock signal by pressing the (-) or (+) button. The level number will increase when the radio wave signal is stronger). Press the (**E**) button to confirm the setting and now the display will show “**P2 Hour diSPly**”

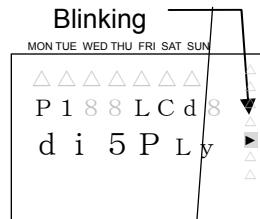

- Press the (**E**) button to select either “**AM PM 12:00**” which is AM/PM display, or “**23:59**” which is the 24 hour display by pressing (-) or (+) button. Press the (**E**) button to confirm your setting and display “**P3 PA55 word**”.

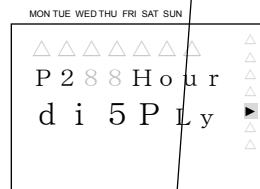

- At **P3 PA55 word**, press the (**E**) button to set the password. The first digit (-) will blink and it can be set by pressing the (-) or (+) button. Once you select the first digit, press (**E**) to confirm and advance to the remaining three digits following the same steps.

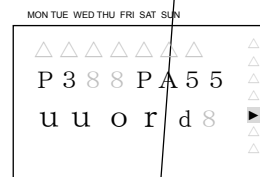

Note: When you would like to cancel the password, change the 1st digit back to “-” and the password will change to “_____”. It is recommended to keep password in a safe place (see directions below if password is lost).

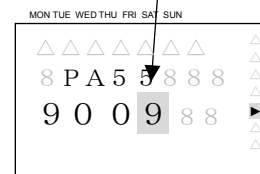

- Press the (**E**) button to confirm the password setting and display “**P4 CloC SynC**” to set the time zone (for US only), select the Official Standard Frequency (Europe), and whether the Atomic Clock function is on or off.

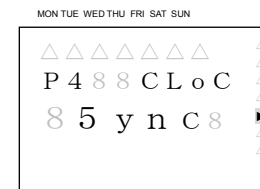

If the PIX-200 requires a password

- When you press the (+) and (E) button at the same time for 2 seconds to enter the “set up program” display.
- When you press the (+1 HOUR) or (+1 MIN.) button to change the time.

In case you forget the password

You can enter the “set up program” display by entering “1441”. Make sure you only use the (-) button when you input this password or this password will not work.

Note: Once a password has been entered, whenever you attempt to press the (+) and (E) buttons on the top of the unit at the same time, and hold down for 2 seconds you will see PASS “_ _ _ _” with the left “_” blinking to begin entering the 4 digit password. Once the correct password has been entered, **SEt UP Pro9** will appear on the display and you can perform changes to setup.

Chapter 4: Atomic Clock Feature

The PIX-200 has the atomic clock (radio-controlled clock) feature which displays the current time precisely by automatically receiving time code signals on long wave radio from a transmitting station. The unit receives the time code signal via its built-in antenna system.

PIX-200 can receive standard frequencies from the countries listed in the following table.

Country	Specification	Official Standard Frequency	Transmitting Station
United States	Standard	WWVB/60kHz	Fort Collins, Colorado
Germany	Optional	DCF/77.5kHz	Mainfligen, Frankfurt
United Kingdom	Optional	MSF/60kHz	Rugby
Japan	Optional	JJY/40kHz	Fukushima (East Japan)
	Optional	JJY/60kHz	Saga (West Japan)

In the United States for more information about the WWVB-Radio signal visit NIST's **website at: www.boulder.nist.gov**

For actual signal coverage in North America visit:

<http://www.boulder.nist.gov/timefreq/stations/wwvbcoverage.htm>

Note: The atomic clock function is only available for the country in which you have purchased PIX-200.

The Atomic Time Synchronization Indicator in the LCD display indicates the status of the signal as illustrated below.

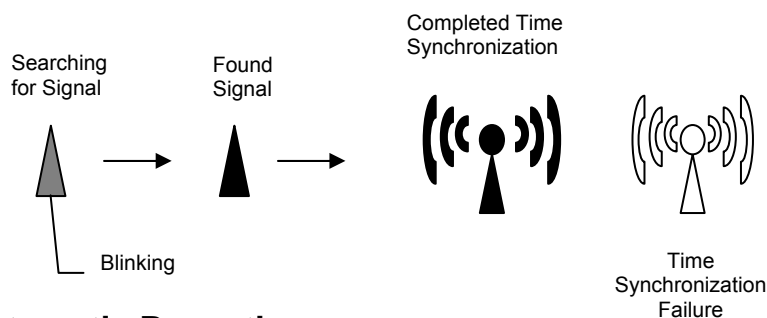

Automatic Reception

- The atomic clock feature will automatically start searching for time code signals under the following conditions. (Refer to paragraph "PIX-200 Atomic Clock/Time Code Signal" at the end of this chapter for details about reception duration)

- 1) Every time you plug in the unit it will search for the signals for 15 minutes.
 - 2) Every night starting at 1:15am until 4:00am (For 2 hours 46 minutes) when the unit is connected to the AC adapter.
- When the time displayed on the unit is different by more than ± 15 minutes from the official standard time of the location, you can perform one of the following actions:

- 1) Remove the cover and press (-) and (E) button at the same time for two seconds. The "L-0 USA", "L-0 Geny (Germany)" or "L-0 brtn (UK)" display will appear. Press (+) button and the unit will start searching for time code signals. The level of the radio wave strength will be displayed from "L-0" to "L-6". "L-6" means that the radio wave is very strong. Press the (E) button to stop searching for time code signals.

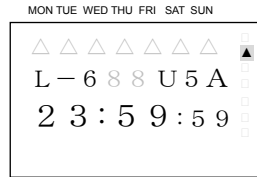

- 2) Change the time manually. (Please refer to *page 3-1*, "Setting the Time", or *page 3-2*, "Easy Way to Set the Time").

Note:

- When the "Completed Time Synchronization" symbol is on, it means that the unit has received the time code signal within 24 hours.
- The clock may display the wrong time. This may happen if it fails to receive radio wave signals properly because of interference, an inappropriate location, or bad radio wave receiving conditions. Should this happen, move the clock to another place such as near a window where it can receive radio wave signals.
- Please face the ribbon carriage side of the unit to the direction of the radio wave signals.
- Even if the clock is unable to receive radio wave signals, its Quartz mechanism will continue to keep the time.

Inappropriate places to keep the unit

Please note that the clock may be unable to receive radio wave signals properly under the following conditions.

- Inside a large building, between tall buildings, underground, building without windows.
- Close to overhead power lines, TV stations and train cables.
- Close to home electrical appliances or devices such as TV's, PC's, refrigerators or fax machines.

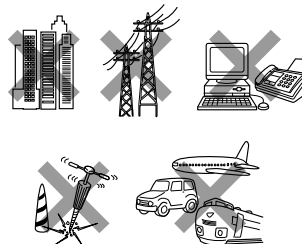

- Close to furniture made of steel, such as steel desk.
- In places generating radio interference, such as near construction sites, airports or in heavy traffic.
- Inside a vehicle, train or airplane.

Setting the Atomic Clock (Germany, UK and others)

In this setup, you can select DCF in Germany, MSF in UK or disable the Atomic Clock function. The factory default is set to DCF in Germany.

1. Unlock and remove the cover.
2. Press **(+)** and **(E)** button on top of the unit at the same time, holding down for 2 seconds until **"SEt UP Pro9"** appears on the display.
2. Press the **(+)** button eleven times to position the **"▲"** alongside the 5th line down from the upper righthand corner of the display alongside **"OTHERS"** (on the label).
3. Press **(E)** button and you will see **"P1 LCd diSPly"** display. Press **(+)** button 3 times to advance to **"P4 CloC 5Ync"** display.
4. Press **(E)** button to select official standard Atomic Clock frequency or disable the Atomic Clock. If you are in Europe, you can select from **"GErAny"** (DCF in Germany), **"britAN"** (MSF in UK) or **"oFF"**. (Disable the atomic clock) by pressing **(-)** or **(+)** button. In case of other countries, you can select either **"on"** or **"oFF"** by pressing **(-)** or **(+)** button.
5. Press **(E)** button to confirm your setting and return to **"SEt UP Pro9"** display

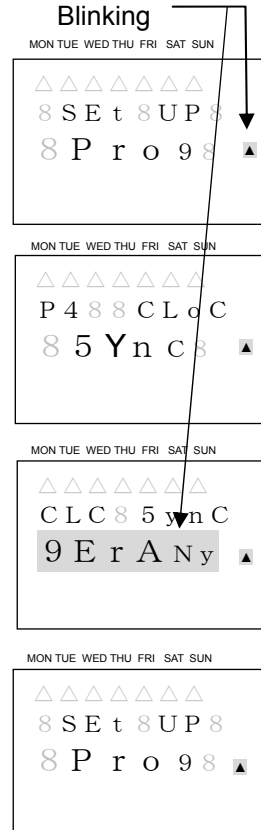

Setting the Time Zone (US only)

This setup is for US only. In this setup, you can set the time zone or select to disable the Atomic Clock function.

1. Unlock and remove the cover.
2. Press (+) and (E) button on top of the unit at the same time, holding down for 2 seconds until “**SEt UP Pro9**” appears on the display.
3. Press the (+) button eleven times to position the “▲” alongside the 5th line down from the upper righthand corner in the display alongside “OTHERS” (on the label).
2. Press (E) button and you will see “**P1 LCd diSPly**” display. Press (+) button 3 times to advance to “**P4 CloC 5ync**” display.
3. Press (E) button to set the time zone. When you set the time zone, you need to input the time difference from UTC (Universal Time Coordinated). Please refer to the following chart.

Time Difference from UTC	Time Zone	Major Cities
-5	EST	New York, Boston
-6	CST	Chicago, Houston
-7	MST	Phoenix, Denver
-8	PST	Los Angeles, San Francisco

For example, using the chart above, **t 2onE** with **- 5:00** should appear on the display for Eastern Time Zone (EST).

4. When you see the “**t 2onE**” display where the hour is blinking, select the time difference by pressing (-) or (+) button. Press (E) button to confirm the setting, and go to the “**P5 End**” display.
5. If you need to disable the Atomic Clock function because of a failure to receive the radio signal, interference, an inappropriate location, or just bad radio wave receiving conditions, please press (-) or (+) button until you see “**CLC 5ync OFF**”. Press the (E) button to confirm the setting, and go to the “**P5 End**” display.

Note: if the unit can't receive radio signals, try moving the unit to another place where it can receive radio signals.

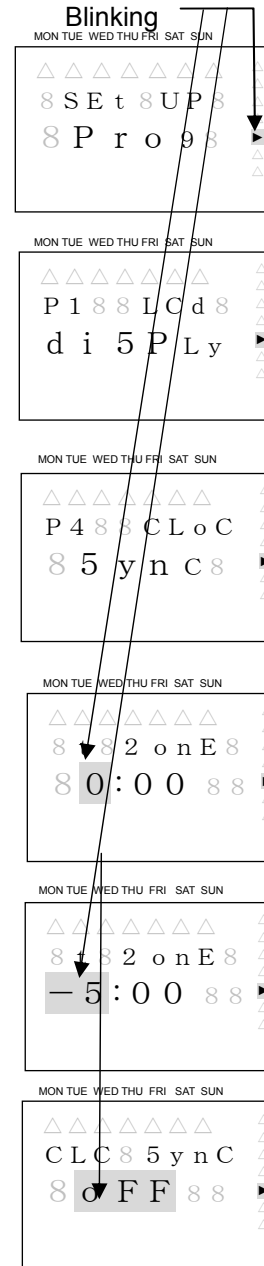

6. Press the **(E)** button again to return to the “**SEt UP Pro9**” display.

PIX-200 Atomic Clock/Time Code Signal

Following is the amount of time for the PIX-200 to receive time code signals:

- When the radio wave condition is good, the clock will require approximately 3 minutes to complete synchronization.
- During the automatic reception every night (from 1:15 am to 4:00 am), it may take up to 166 minutes to complete time synchronization depending on the radio wave reception.
- When you manually start reception, the clock will continue to search for time code signals until this operation is discontinued. Refer to page 4-1 through 4-4 for more information about manual atomic clock activation.

This page intentionally left blank.

Chapter 5: Maintenance and Troubleshooting

Ribbon Cartridge Replacement

NOTE: Before replacing the ribbon cartridge, disconnect the power plug from the power outlet.

1. Insert the key provided and turn counterclockwise to unlock the cover. Lift the cover to remove.
2. Pull the two ribbon release tabs upward.
3. While holding the release tabs in an upward position, pull the ribbon cassette out of the cradle.
4. If the print mechanism is down and a piece of paper cannot be inserted, unplug the clock, then plug it back in to move the carriage up. This will make the ribbon installation easier.

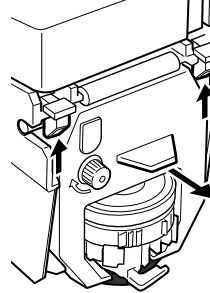

5. Insert a new ribbon underneath the printer head as shown.
6. Turn the knob on the cassette clockwise one turn to take up any slack in the ribbon.
7. Check the printing quality to confirm that you have installed the ribbon properly.
8. Reset the INK capacity gauge by pressing the (+) and (-) buttons at the same time for more than 2 seconds.
9. Replace the cover.

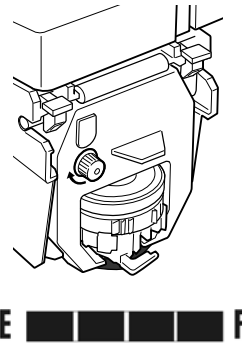

Cleaning

For cleaning, unplug the power cord and wipe the case with a dry cloth. Do not use any chemical solvents or oils to clean or lubricate your PIX-200. This will damage your clock.

To clean the inside of your clock, blow it out with compressed air.

Error Codes

In the event of an error, an error code will appear in the display. The error codes are listed below with their possible causes and solutions. The error code will be displayed for 2.5 seconds.

Error Code	Cause
Error 02	Home Sensor Error when starting imprint
Error 03	Timing Sensor Error
Error 04	Home Sensor Error when finishing imprint
Error 05	Printing Length Setting Error

For error codes **02** through **04**, unplug the clock before checking to see that the carriage is not stuck or jammed. Also, check to see that the ribbon cables are in good condition and that the ribbon cassette is correctly inserted in place. After clearing any jams, plug the clock back in.

The **05** error code signifies that the print length should be changed by adjusting the Year Digit, Type of Hour, Language type, and Digit Number.

If the error does not disappear, please contact your AMANO Cincinnati, Inc. representative for assistance.

Note: Printing errors can be caused by the absence of grease on the printing carriage mechanism. If this occurs, the carriage mechanism may not slide smoothly. This movement restriction may cause the printer to display a print error and stop working. If this occurs, apply white silicone grease to the horizontal metal plate that the carriage mechanism slides against. This is illustrated in the following drawing,

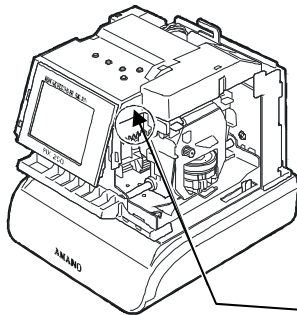

Place white silicone grease here

Chapter 6: Appendix

Diagram of preprogrammed comments and languages.

	Japanese	English	Spanish	French	German	Italian	Portuguese	Roman no.	No.
Monday	月	MO	LU	LU	MO	LU	SG	I	1
Tuesday	火	TU	MA	MA	DI	MA	TR	II	2
Wednesday	水	WE	MI	ME	MI	ME	QU	III	3
Thursday	木	TH	JU	JE	DO	GI	QU	IV	4
Friday	金	FR	VI	VE	FR	VE	SX	V	5
Saturday	土	SA	SA	SA	SA	SA	SA	VI	6
Sunday	日	SU	DO	DI	SO	DO	DO	VII	7
January	1	JAN	ENE	JAN	JAN	GEN	JAN	I	1
February	2	FEB	FEB	FEV	FEB	FEB	FEV	II	2
March	3	MAR	MAR	MAR	MAR	MAR	MAR	III	3
April	4	APR	ABR	AVR	APR	APR	ABR	IV	4
May	5	MAY	MAY	MAI	MAI	MAG	MAI	V	5
June	6	JUN	JUN	JUN	JUN	GIU	JUN	VI	6
July	7	JUL	JUL	JUL	JUL	LUG	JUL	VII	7
August	8	AUG	AGO	AOU	AUG	AGO	AGO	VIII	8
September	9	SEP	SEP	SEP	SEP	SET	SET	IX	9
October	10	OCT	OCT	OCT	OCT	OTT	OUT	X	10
November	11	NOV	NOV	NOV	NOV	NOV	NOV	X I	11
December	12	DEC	DIC	DEC	DEZ	DIC	DEZ	X II	12
received	RCVD	RCVD	RCBDO	RECU	EING	RICEV	RCBDO	RCVD	RCVD
sent	SENT	SENT	ENVDO	ENV	AUSG	SPED	ENVDO	SENT	SENT
faxed	FAXED	FAXED	FAX	FAXE	FAX	FAX	FAX	FAXED	FAXED
void	VOID	VOID	ANLDO	ANUL	LAGER	ANUL	ANUL	VOID	VOID
paid	PAID	PAID	PGADO	PAYE	BEZ	PAGA	PAGO	PAID	PAID
confirmed	CFMD	CFMD	CONF	CONF	EMPF	CONF	CONF	CFMD	CFMD
approved	APRD	APRD	APBDO	APPR	BEST	APPR	APRV	APRD	APRD
completed	CMLD	CMLD	TRBDO	TERM	ABGES	COMPL	TERM	CMLD	CMLD
origin	ORIGN	ORIGN	ORIGN	ORIG	ORIG	ORIG	ORIG	ORIGN	ORIGN
file	FILE	FILE	ARCH	FICH	AKTE	FILE	ARQV	FILE	FILE
in	IN	IN	ENTRA	ENTRE	KOMT	ENTRA	ENTRA	IN	IN
out	OUT	OUT	SALID	SORTI	GEHT	USCIT	SALID	OUT	OUT
used	USED	USED	UTIL	UTIL	GERRA	UTIL	UTIL	USED	USED

Diagram of Character Code

The alphanumeric characters on the upper row are for the first digit of the code and the ones on the far left column are for the second digit of the code.

For example, if you want to program:

"(Year)(Month)(Date)(SP)(Hour)(:)(Minute)(AM/PM)(SP)(A)(M)(A)(N)(O)"

the code will be; 10, 11, 12, 20, 13, 3A, 14, 1C, 20, 41, 4D, 41, 4E, 4F

and the PIX-200 would print the following:

IMPRINT IMAGE: '05DEC 15 8:23AM AMANO

Note: Space characters in the bold square shown in the following illustration will not be recognized as one-byte font (7 dots in width), but instead will be recognized as a narrow font (5 dots in width). When "In" is placed before the space character when changing the font size, the font will be bigger. Please refer to the diagram showing the fonts.

Space Character

d/u	0	1	2	3	4	5	6	7	8	9	A	B	C	D	E	F
0	En	(Year)	SP	0	@	P	`	p	I	受		Λ				
1	dL	(Month)	!	1	A	Q	a	q	II	領		E				1 Dot SP
2	in	(Date)	"	2	B	R	b	r	III	収	Γ	Π				2 Dot SP
3		(Hour)	#	3	C	S	c	s	V	検	Γ	Σ				3 Dot SP
4		(Minute)	\$	4	D	T	d	t	X	付	\	Φ				4 Dot SP
5		(Second)		5	E	U	e	u	-	年	.	Ψ				5 Dot SP
6		(Day of the week)	&	6	F	V	f	v	`	月	Æ					6 Dot SP
7		(Week No.)	'	7	G	W	g	w	"	日	Ä					7 Dot SP
8		(Julian Date)	(8	H	X	h	x	▪	平	∅					8 Dot SP
9		(Number))	9	I	Y	i	y	\		Ö					9 Dot SP
A		(Repeat Time)	*	:	J	Z	j	z			Ä					J
B		(Preprogrammed Comment)	+	;	K	[k	{			É					Jn
C		(AM/PM)	,		L	\	l				Ä					L
D			-		M]	m	}			Γ					LL
E			.		N	^	n	~			Δ					Ln
F			/		O	_	o				Θ					Un

Code	Function
in	Insert character
dL	Delete character
En	End of the sentence

Code	Function
J	Start Two-Byte
Jn	Undo Two-Byte
L	Start Emphatic Byte
LL	Start Double-Width Byte
Ln	Undo Emphatic/Double-Width Byte
Un	Undo Space Character

Diagram of Font

The maximum dots, which can fit into one line is a total of 148 dots.

	Character	Font	Dots	Character Code
I	Common One-Byte	One-Byte	7	From 10 to 89, A1 to A4 (Excluding IV, V, VI)
		Emphatic	8	
		Double-Width	13	
II	Common Two-Byte	Two-Byte	9	
		Emphatic	10	
		Double-Width	17	
III	Special Symbols	Two-Byte	9	From A6 to B5
		Emphatic	10	
		Double-Width	17	
IV	Space Character			+ "Un"
		---	5	7
		Emphatic	6	8
		Double-Width	9	13
V	Second	One-Byte	7	15
VI	AM/PM	Fixed	13	1C
VII	Chinese Character	Fixed	10	From 90 to 98

Diagram of printing type for minutes

Min	0	1	2	3	4	5	6	7	8	9	25	26	27	28	29	30	31	32	33	34	35	51	52	53	54	55	56	57	58	59
60 (1/60)	00	01	02	03	04	05	06	07	08	09	25	26	27	28	29	30	31	32	33	34	35	51	52	53	54	55	56	57	58	59
10 (1/10)	0	0	0	0	0	0	1	1	1	1	4	4	4	4	4	5	5	5	5	5	5	8	8	8	8	9	9	9	9	9
100B (5/100)	0	0	0	05	05	10	10	10	10	15	40	40	45	45	45	50	50	50	55	55	55	85	85	85	90	90	90	95	95	95

100A = One hour (3,600 seconds) is divided by 100 and the minutes are printed in a 00-99 range. The minute increments by 1 every 36 seconds and seconds are printed in a 00-35 range.

60 th (mins)	100A (mins)
:00 00s	.00 00s
▪	▪
:00 35s	.00 35s
:00 36s	.01 00s
<hr/>	
:33 00s	.55 00s
:33 01s	.55 01s
▪	▪
:33 35s	.55 35s
:33 36s	.56 00s
<hr/>	
:59 24s	.99 00s
▪	▪
:59 57s	.99 33s
:59 58s	.99 34s
:59 59s	.99 35s

The minute increments by 1 every 36 seconds

$$33 \text{ minutes} = 33/60 * 100 = 55$$

NOTES

NOTES

AMANO®

Corporate Headquarters
140 Harrison Avenue, Roseland, NJ 07068-1239
(800) 526-2559

www.amano.com/time